

Technical Information

DUSK 02

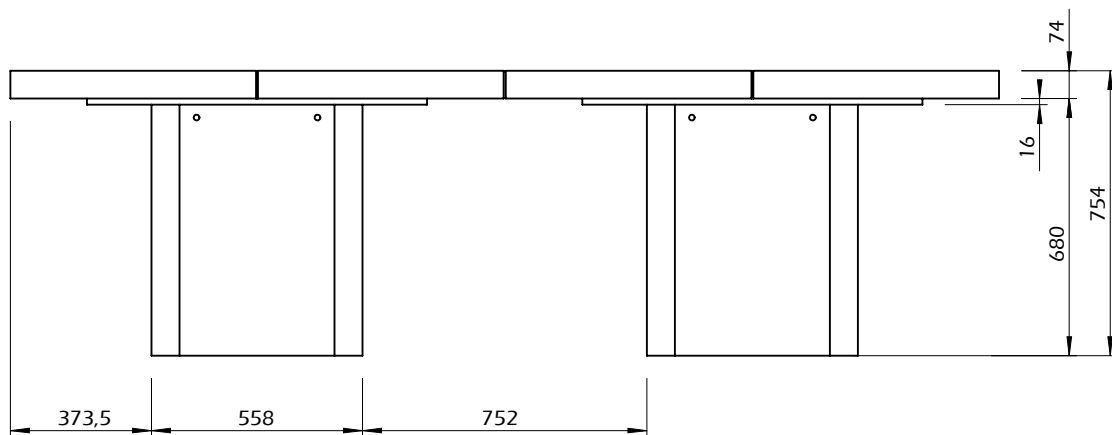
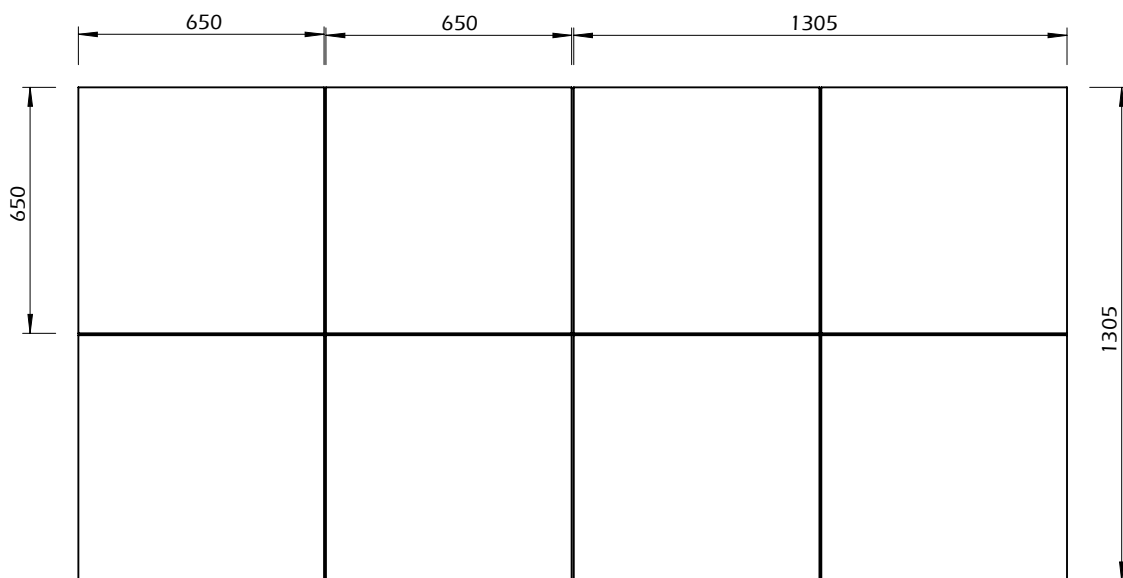
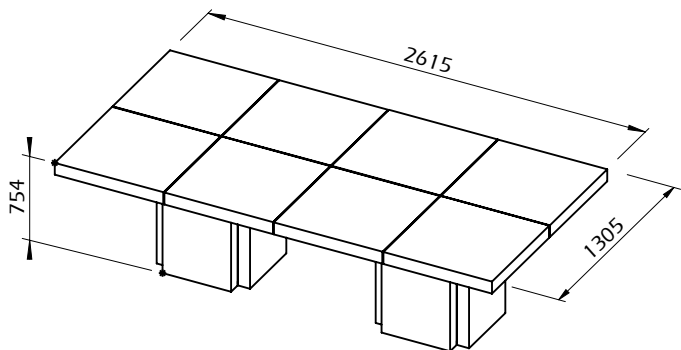

60min
x2

50kg
x2

10x

IT-1363-STD/02